

# LUMENOLOGY™

DUAL SECURITY MOTION LIGHT

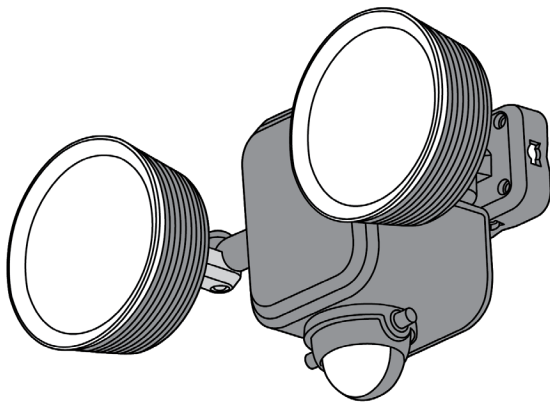

## User Manual



# Table Of Contents

---

Safety Information.....	1-2
Introduction / What's Included .....	3
Components.....	4
Technical Specifications .....	5
Operating Instructions .....	6-17
How to Set Up the Lumenology Dual Security Motion Light .....	6-8
Sensor Detection Range .....	9
How to Install the Lumenology Dual Security Motion Light .....	10-12
How to Adjust the Motion Sensor .....	13
How to Adjust the Body Position .....	13-14
How to Set the Mode.....	15
How to Set the Duration .....	16
Red LED Indicator Light.....	17
Certification.....	18
Limited Warranty .....	19-22
Copyright Notice.....	23
FCC Notice.....	24

# Safety Information

---

By using the Lumenology Dual Security Motion Light, you hereby agree that Limitless Innovations, Inc., an Illinois corporation and its affiliates ("Limitless") shall have no liability for any losses associated with property damage, personal injury or loss of life that are incurred by you or by any third party in connection with or relating in any manner whatsoever to your use of the Lumenology Dual Security Motion Light. By using the Lumenology Dual Security Motion Light, you hereby agree at all times to comply fully with all safety warnings, operating instructions and general safety information in this user manual. By using the Lumenology Dual Security Motion Light, you further agree to hold harmless Limitless, (and Limitless' officers, directors, shareholders and employees) in connection with any losses sustained by you (including, without limitation, losses arising in whole or in part from property damage, personal injury or loss of life) relating in any manner whatsoever to your use of the Lumenology Dual Security Motion Light.

## SAFETY WARNINGS

- Please keep the Lumenology Dual Security Motion Light and all accessories out of reach of small children.
- Do **NOT** use third party power supplies or non-approved adapters with the Lumenology Dual Security Motion Light.
- Do **NOT** attempt to open the outer casing of the Lumenology Dual Security Motion Light.
- Do **NOT** clean the Lumenology Dual Security Motion Light with harsh chemicals and keep the Lumenology Dual Security Motion Light away from liquids.
- Do **NOT** expose the Lumenology Dual Security Motion Light to extreme temperatures.
- Do **NOT** paint or apply coatings to the Lumenology Dual Security Motion Light, as you might affect moving parts or damage internal components.
- Do **NOT** stick foreign objects in any port/opening of the Lumenology Dual Security Motion Light. Doing so may cause electric shock.
- Do **NOT** attempt to disassemble or repair the Lumenology Dual Security Motion Light. Contact customer service for technical assistance at (855) 843-4828.
- Do **NOT** drop the Lumenology Dual Security Motion Light. Doing so may damage internal components otherwise not seen and must **NOT** be operated.
- Do **NOT** submerge the Lumenology Dual Security Motion Light or its accessories in water.
- Disassembling the Lumenology Dual Security Motion Light, including the removal of external screws, may cause damage that is not covered under the warranty. Contact customer service for technical assistance at (855) 843-4828.

## Safety Information cont'd

---

- Do **NOT** mix new and old batteries. It may cause the LED Light to malfunction.
- Do **NOT** look directly at the LED Light.
- Do **NOT** mix Alkaline, Standard (Carbon-Zinc) or Rechargeable (Nickel Cadmium) or (Nickel Metal Hybrid) batteries.
- Do **NOT** install the main body in places where large amount of water may come in contact with the Lumenology Dual Security Motion Light.
- Do **NOT** use near home electric appliances.
- Do **NOT** install diagonally, downward, or upside down regardless of indoor or outdoor use as it may cause failure.
- Do **NOT** install near combustibile objects.
- Do **NOT** install near flammable materials such as cloth, paper, or objects that may easily catch fire.
- Do **NOT** use manganese, dry, or rechargeable batteries. It may cause a malfunction due to voltage shortage.
- Do **NOT** install near appliances emitting radio waves as it may cause failure.
- Do **NOT** install near motors or devices generating a magnetic field. May cause failure.

# Introduction

---

## LUMENOLOGY DUAL SECURITY MOTION LIGHT

The Lumenology Dual Security Motion Light is an ultra-bright, 1000 Lumen LED Light that will instantly improve a home's security. Includes MotionSense Technology that boast a 20FT detectable range and 140° field-of-view, while LightSense Technology allows for adjustment of detecting motion in both light and dark environments. The dual adjustable LED Lights and Motion Sensor make it a perfect fit anywhere around a house or office building.

### WHAT'S INCLUDED

- 1x Lumenology Dual Security Motion Light
- 1x L-Rod
- 1x Butterfly Nut
- 1x Plastic Cap
- 1x Clamp
- 4x Plastic Anchors
- 4x Screws
- 1x User Manual

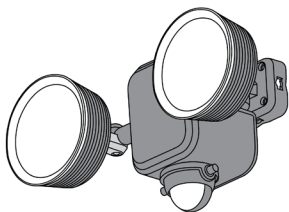

Lumenology Dual Security Motion Light

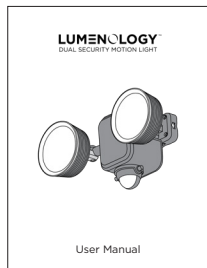

User Manual



L-Rod



Butterfly Nut



Plastic Cap

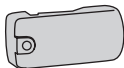

Clamp



Plastic Anchors



Screws

# Components

1. Mounting Holes
2. LED Light
3. Red LED Indicator Light
4. Motion Sensor
5. Adjustable Arm
6. L-Rod Slots
7. Mounting Bracket
8. Bracket-to-Arm Screw
9. Battery Cover
10. Battery Cover Thumb Screw
11. Timer Knob
12. Light Sensitivity Knob
13. Inner Battery Cover
14. Battery Box
15. Clamp
16. L-Rod

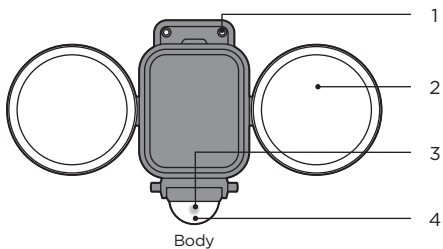

Body

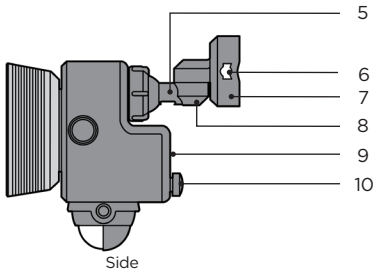

Side

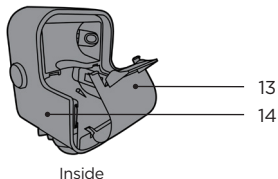

Inside

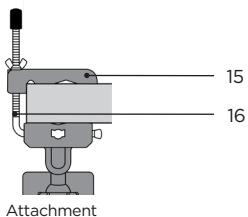

Attachment

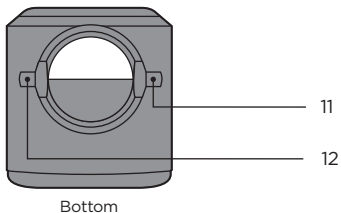

Bottom

# Technical Specifications

---

Title	Specification	Units
Bulb	High-Luminance White LED	N/A
Battery	3x D Dry Cell	N/A
Brightness	1,000LM	Lumen
Activations	Approx. 1,530 (Based on the 30-second auto shut-off mode)	N/A
Modes	10s / 20s / 30s Auto Shut-Off	Seconds
Light Sensor Mode	Adjustable - Day / Night	N/A
Detecting Method	Motion	N/A
Detectable Range	140°, 20FT MAX	Degrees, Feet
Adjustable Range	360°	Degrees
Size / Weight	11IN x 6.9IN x 6IN   18.7oz	Inches   Ounces
Attachment Options	Mechanically Fastened / Clamp	N/A

\*LED Bulb is **NOT** replaceable.



# Operation Instructions

---

## HOW TO SET UP THE LUMENOLOGY DUAL SECURITY MOTION LIGHT

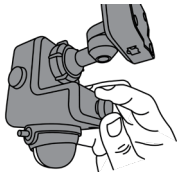

1. Turn the Battery Cover Thumb Screw counterclockwise until the Battery Cover is detached from the Battery Box of the Lumenology Dual Security Motion Light and pull away.

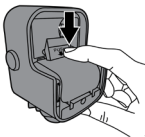
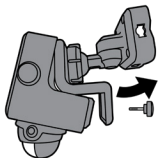

2. Disengage the Inner Battery Cover by pressing down where the Inner Battery Cover is labeled "PUSH" and pull away.

**NOTE:** The Inner Battery Cover does **NOT** disconnect completely. It rotates on a 90° axis. Do **NOT** push against the Inner Battery Cover when it is open as it may break.



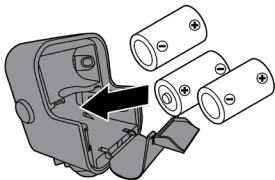

4. Insert 3x D Batteries and be sure to align the positive (+) and negative (-) terminals correctly. (Batteries sold separately).

**CAUTION:** Some equipment using three or more batteries may appear to work properly even if one battery is inserted incorrectly; such usage may lead to battery leakage or rupture that could result in equipment damage.

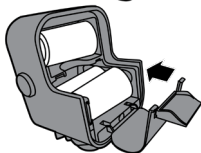

5. Rotate the Inner Battery Cover back into place. Push in until it clicks and does not rotate freely.



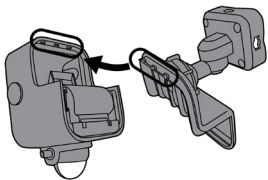

6. Close the Battery Box by first aligning the three tabs on the Battery Cover to the three notches in the Battery Box (Shown left).

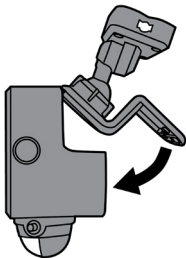

7. Turn the Battery Cover downward until completely closed.

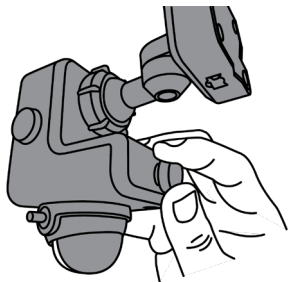

8. Rotate the Battery Cover Thumb Screw clockwise until the Battery Cover is tightened and secured to the Battery Box.

## SENSOR DETECTION RANGE

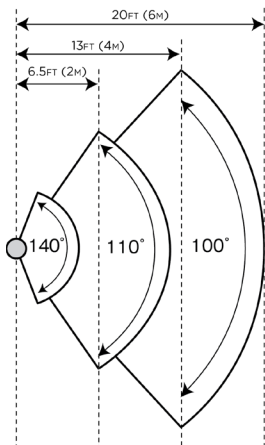

1. The Motion Sensor can detect movement in a max field-of-view of 140° and a max distance of 20FT.

### NOTES:

- The Motion Sensor is less likely to detect motion when walking directly towards the unit.
- The detection area performs best when set to a height of 6.5FT (2M) high.

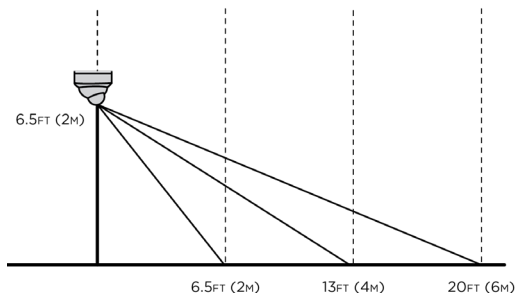

## HOW TO INSTALL THE LUMENOLOGY DUAL SECURITY MOTION LIGHT

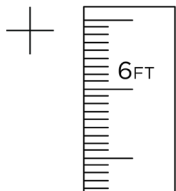

### USING BRACKET

1. Measure, locate, and mark where the Lumenology Dual Security Motion Light will be installed.

**NOTE:** It is recommended to install the Lumenology Dual Security Motion Light directly to a wooden stud, metal stud or plywood wall sheathing.

2. Place the Mounting Bracket on the spot marked in step 1.
3. Using a pencil, mark the location through the 4 Mounting Holes as shown.

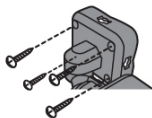
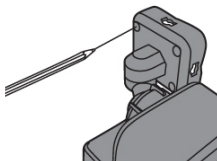

### Wood Stud, Metal Stud or Plywood Wall Sheathing:

- 4a. Fasten the Mounting Bracket directly to the wall with the 4 included Screws. No additional Anchors are necessary.

### Dry Wall Without Stud:

- 4b. Remove the Mounting Bracket to expose the marks made in step 3 above.
- 5b. Pre-drill 1/8" holes at each of the marked locations.
- 6b. Insert an Anchor into each drilled hole from step 5b. You may need to lightly hammer the Anchors in place.
- 7b. Place the Mounting Bracket to align the Mounting Holes with the Anchors.
- 8b. Fasten the Lumenology Dual Security Motion Light to wall with the 4 supplied Screws.

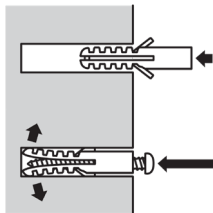

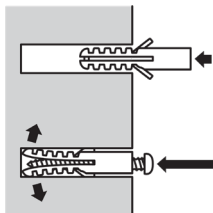

### Concrete:

- 4c. Remove the Mounting Bracket to expose the marks made in step 3 on page 10.
- 5c. Pre-drill 1/4" holes at each of the marked locations.
- 6c. Insert an Anchor into each drilled hole from step 5c. You may need to lightly hammer the Anchors in place.
- 7c. Place the Mounting Bracket to align the Mounting Holes with the Anchors.
- 8c. Fasten the Lumenology Dual Security Motion Light to wall with the 4 supplied Screws.

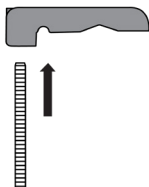

### USING CLAMP

1. Slide the threaded end of the L-Rod through the Clamp (shown left).

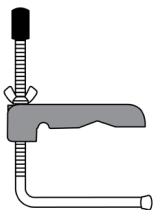

2. Thread the Butterfly Nut onto the L-Rod by rotating clockwise. Do not thread all the way down at this time.
3. Add Plastic Cap to the threaded end of the L-Rod.

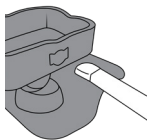

4. Insert the flat end of the L-Rod into the L-Rod Slots on the Mounting Bracket.

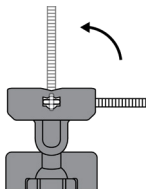

5. Rotate the L-Rod 90° to keep the Lumenology Dual Security Motion Light from sliding off.

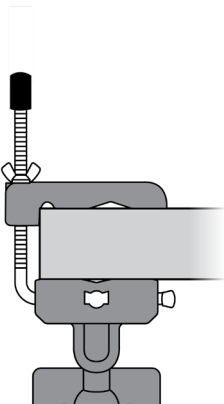

6. Place the Lumenology Dual Security Motion Light with the hanging surface in-between the Clamp and Mounting Bracket (shown left).

7. Once the Lumenology Dual Security Motion Light is in the desired position, continue to thread the Butterfly Nut clockwise until tight and secure.

8. Adjust the LED Lights, Adjustable Arm and Motion Sensor as shown in the following steps until satisfied with the positioning.

# Operation Instructions cont'd

## HOW TO ADJUST THE MOTION SENSOR

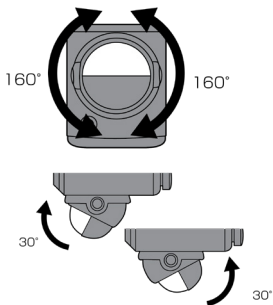

1. Grab the Motion Sensor along two sides and rotate left, right, up or down until the preferred positioning is achieved.

### NOTES:

- Do **NOT** force any movement as it may cause damage to the Motion Sensor.
- The Motion Sensor will only rotate left / right 160° and up / down 30°.

**Maximum Field-of-View:** Adjust the Motion Sensor horizontally.

**Minimum Field-of-View:** Adjust the Motion Sensor diagonally downward.

## HOW TO ADJUST THE BODY POSITION

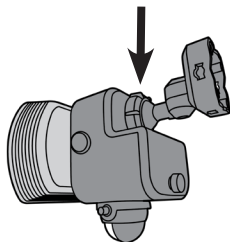

1. Loosen the Adjustment Knob by turning counterclockwise and the Adjustment Arm moves freely.
2. Rotate and move the Lumenology Dual Security Motion Light until the desired position is reached.
3. Hold and re-tighten the Adjustment Knob by turning it clockwise.

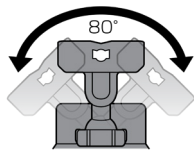
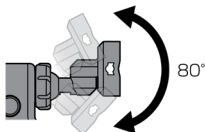
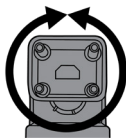



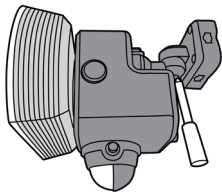

2. For additional movement to the Adjustable Arm, loosen with the Bracket-to-Arm Screw by turning counterclockwise. This will allow the Adjustable Arm to rotate an additional 160° side-to-side. Once the desired positioning is achieved, re-tighten the Bracket-to-Arm Screw by turning clockwise.

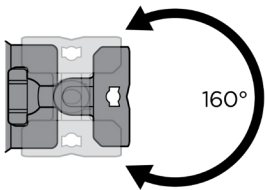

**NOTE:** For complete adjustment capabilities, loosen the Adjustment Knob and Bracket-to-Arm Screw at the same time.

### HOW TO SET THE MODE

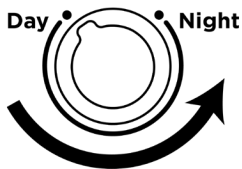

1. Adjust the Light Sensitivity Knob to align the dial to Day, Night or somewhere in-between to better suit the surroundings or preferences.

**Day:** LED Light is activated by motion regardless of whether the surrounding area is bright or dark.

**Night:** LED Light is only activated by motion when the surrounding area is dark.

**NOTE:** If additional Light is preferred in a bright environment, the Light Sensitivity Knob should be moved to the Day position.

### HOW TO SET THE DURATION

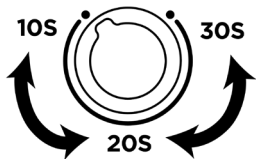

1. To adjust the timer, turn the Timer Knob until the dial aligns with one of the time durations.

**10S:** Once motion is sensed and the LED Light is activated, the LED Light will remain on for approximately 10-seconds unless motion is detected again.

**20S:** Once motion is sensed and the LED Light is activated, the LED Light will remain on for approximately 20-seconds unless motion is detected again.

**30S:** Once motion is sensed and the LED Light is activated, the LED Light will remain on for approximately 30-seconds unless motion is detected again.

**NOTE:** The angle between durations is not proportional to time.

## RED LED INDICATOR LIGHT

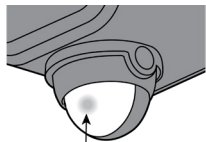

Red LED

1. The Red LED Indicator Light will flash at different intervals depending on certain criteria (see below).

**NOTE:** The Red LED Indicator Light is easiest viewed in a dark environment.



1. Blinks once every 5 seconds: stand-by mode.



2. Blinks quickly: Motion Sensor is detecting movement.



3. Blinks once every second: The batteries are low and the LED Lights will only activate in darkness.



4. OFF: There are no batteries in the Lumenology Dual Security Motion Light or the batteries need to be replaced.

# Certification

---

## **IP44 RATING**

This device complies with IP44 enclosures. IP44 protects against water spray from any direction. IP (or "Ingress Protection") ratings are defined in international standard EN 60529 (British BS EN 60529:1992, European IEC 60509:1989). They are used to define levels of sealing effectiveness of electrical enclosures against intrusion from foreign bodies (tools, dirt etc) and moisture. The numbers that follow IP each have a specific meaning. The first indicates the degree of protection (of people) from moving parts, as well as the protection of enclosed equipment from foreign bodies. The second defines the protection level that the enclosure enjoys from various forms of moisture (drips, sprays, submersion etc).

# Limited Warranty

---

Your use of the product shall at all times require you to comply with all terms, conditions of use, instructions and recommendations set forth within the User Manual and the ChargeHub Terms and Conditions found at:

**Manual:** [LimitlessInnovations.com/Manual/Lumenology-Dual.pdf](https://LimitlessInnovations.com/Manual/Lumenology-Dual.pdf)

**Warranty Terms and Conditions:** [LimitlessInnovations.com/Warranty-Terms-and-Conditions/Lumenology-Dual](https://LimitlessInnovations.com/Warranty-Terms-and-Conditions/Lumenology-Dual)

Are you having issues with your Limitless product?

**Contact our support team today at:**

**[LimitlessInnovations.com/Support](https://LimitlessInnovations.com/Support) or call us at (855) 843-4828**

Subject to the exclusions contained below, Limitless Innovations, Inc. (“Limitless”) warrants the Limitless product to be free from defects in materials and workmanship under normal consumer usage for a period of one (1) year from the date of original purchase, (the “Limitless Limited Warranty”). As utilized herein, the term “Limitless” (or the singular, Limitless product) shall include all products set forth above in the what’s included section of this User Manual that may be sold by Limitless now or in the future.

This Limitless Limited Warranty is a consumer’s sole and exclusive remedy regarding any express warranty claim by a consumer and is subject to the exclusions on the following pages:

**Exclusions:** The Limitless Limited Warranty shall not apply in the event of the occurrence of any of the following:

- 1. Normal Wear and Tear.** The Limitless Limited Warranty shall not apply to cover the maintenance, repair and/or replacement of parts or the Limitless Product due to normal wear and tear by the consumer.
- 2. Abuse and Misuse.** The Limitless Limited Warranty shall not cover defects or damage that result in whole or in part from: (a) improper operation, storage, misuse or abuse, accident or neglect by the consumer (including, without limitation, physical damage, cracks and scratches to the surface of the Limitless product); (b) contact with liquid

## Limited Warranty cont'd

---

water, rain, extreme humidity or heavy perspiration, sand, dirt or the like, extreme heat, or food; (c) use of the Limitless Product for commercial purposes; (d) subjecting the Limitless Product to abnormal usage or conditions; and/or (e) other acts which are not the sole and absolute fault of Limitless.

**3. Unauthorized Service or Modification.** The Limitless Limited Warranty shall not cover defects or damages resulting in whole or in part from service, testing, adjustment, installation, maintenance, alteration, or modification in any way by someone other than Limitless or its authorized service centers.

**4. Altered Products.** The Limitless Limited Warranty shall not cover defects or damages to a Limitless Product with (a) serial numbers or date tags that have, at any time, been removed, altered, or obliterated; (b) broken seals or evidence of tampering; (c) mismatched board serial numbers; and/or (d) non-conforming or non-Limitless housings, or components.

**5. Communication Services.** Defects, damage, or the failure of the Limitless Products or software due to any communication service or signal you may subscribe to or use with the Limitless Product or software.

### WHO IS COVERED?

This warranty extends only to the first consumer purchaser and is not transferable to any third party nor applicable to any subsequent owner other than the first consumer purchaser.

### WHAT WILL LIMITLESS DO?

If Limitless determines, in its sole and absolute discretion, that a claim is subject to the Limitless Limited Warranty, it will, at its sole option, repair or replace the Limitless product or alternatively, it will, in its discretion, refund the purchase price of any Limitless products or software. The Limitless product replacement will be with a functionally equivalent reconditioned / refurbished / pre-owned or new Limitless product or part.

For additional information, visit us at:

**[LimitlessInnovations.com/Support](https://www.limitlessinnovations.com/Support) or call us at (855) 843-4828**

## Limited Warranty cont'd

---

### **WHO DO I CONTACT TO MAKE A CLAIM?**

In the event of any warranty claim under the Limitless Limited Warranty, you can contact the telephone number below or provide a written correspondence to the address below at which time and in response thereto, you will receive instructions on how to ship any Limitless product at your expense, to a Limitless authorized repair center. To obtain service, you must include: (a) a copy of your receipt, bill of sale or other comparable proof of purchase; (b) a written description of the problem; (c) the name of your service provider, if applicable; and (d) your mailing address, email address and telephone number.

### **Mailing Address (Please call (855) 843-4828 first to obtain RMA #)**

Limitless Innovations, Inc. | 4800 Metalmaster Way | McHenry, IL 60050

### **WHAT OTHER LIMITATIONS ARE THERE?**

ANY WARRANTY CLAIM SHALL BE LIMITED TO LIMITLESS COST OF MATERIAL ON THE LIMITLESS PRODUCT DETERMINED TO HAVE A MANUFACTURER'S DEFECT. IN NO EVENT SHALL LIMITLESS BE LIABLE TO ANY PARTY FOR ANY LABOR COSTS OR ANY OTHER DIRECT, INDIRECT, CONSEQUENTIAL, INCIDENTAL OR SPECIAL DAMAGES, WHETHER IN CONTRACT OR TORT AND LIMITLESS EXPRESSLY DISCLAIMS LIABILITY FOR ANY DAMAGES OF ANY KIND ARISING UNDER ANY THEORY OF LAW WHATSOEVER. THE PERFORMANCE OF THE LIMITLESS PRODUCT DEPENDS ON THE PURCHASER'S ADHERENCE TO MANUFACTURER PRODUCT INSTRUCTIONS AND LIMITLESS WILL NOT BE RESPONSIBLE TO PURCHASER FOR ANY DEVIATIONS THEREFROM. SOME STATES DO NOT ALLOW THE EXCLUSION OR LIMITATION OF INCIDENTAL OR CONSEQUENTIAL DAMAGES, SO THE ABOVE LIMITATION OR EXCLUSION REGARDING INCIDENTAL OR CONSEQUENTIAL DAMAGES MAY NOT APPLY TO YOU. ALL IMPLIED WARRANTIES, INCLUDING, WITHOUT LIMITATION, THE IMPLIED WARRANTY OF MERCHANTABILITY AND THE IMPLIED WARRANTY OF FITNESS FOR A PARTICULAR PURPOSE SHALL EXPIRE ON THE DATE WHICH IS 1 YEAR FROM THE DATE OF FIRST PURCHASE OF THE LIMITLESS PRODUCT BY THE CONSUMER. SOME STATES DO NOT ALLOW LIMITATIONS ON HOW LONG AN IMPLIED WARRANTY LASTS, SO THE ABOVE LIMITATION MAY NOT APPLY TO YOU. WITH RESPECT TO THAT PERIOD OF TIME BEYOND THE LIMITLESS 1 YEAR LIMITED WARRANTY PERIOD, LIMITLESS DISCLAIMS AND FURTHER MAKES NO WARRANTY OF ANY KIND, EXPRESS OR IMPLIED, INCLUDING BUT NOT LIMITED TO, ANY WARRANTY OF MERCHANTABILITY OR WARRANTY OF FITNESS FOR A PARTICULAR PURPOSE.



### **NATIONAL STATUTORY RIGHTS**

CONSUMERS IN SOME JURISDICTIONS MAY HAVE LEGAL RIGHTS UNDER APPLICABLE NATIONAL LEGISLATION GOVERNING THE SALE OF CONSUMER GOODS, INCLUDING, WITHOUT LIMITATION, NATIONAL LAWS IMPLEMENTING EC DIRECTIVE 99/44. THESE RIGHTS ARE NOT AFFECTED BY THE WARRANTIES IN THIS LIMITED WARRANTY.

## Copyright Notice

---

All Limitless products and information shared in this manual are protected by copyright. Copying, reproducing, reverse engineering or distributing any information of Limitless-related products hardware or software without a formal and written authorization and license from Limitless Innovations, Inc. is prohibited and may result in legal action to the full extent of the law.

## FCC Notice

---

**NOTE:** This equipment has been tested and found to comply with the limits for a Class B digital device, pursuant to Part 15 of the FCC Rules. These limits are designed to provide reasonable protection against harmful interference in a residential installation. This equipment generates, uses and can radiate radio frequency energy and, if not installed and used in accordance with the instructions, may cause harmful interference to radio communications.

However, there is no guarantee that interference will not occur in a particular installation. If this equipment does cause harmful interference to radio or television reception, which can be determined by turning the equipment off and on, the user is encouraged to try to correct the interference by one or more of the following measures:

- Reorient or relocate the receiving antenna.
- Increase the separation between the equipment and receiver.
- Connect the equipment into an outlet on a circuit different from that to which the receiver is connected.
- Consult the dealer or an experienced radio/TV technician for help.

**WARNING:** Changes or modifications to this unit not expressly approved by the party responsible for compliance could void the user's authority to operate the equipment.

# LUMENOLOGY™

## DUAL SECURITY MOTION LIGHT

All rights reserved. Lumenology is a registered trademark of Limitless Innovations, Inc. Design and specifications subject to change without notice. Products may vary from images shown. All other trademarks included herein are property of their respective owners.

Made in China

(855) 843-4828

Support@LimitlessInnovations.com

LimitlessInnovations.com

© Limitless Innovations, Inc.



@LimitlessInnovations



/LimitlessInnov



/LimitlessInnov



/LimitlessInnov



Limitless Innovations