

# User Manual

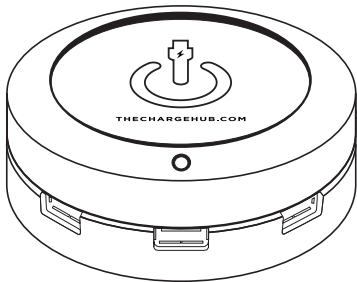

**ChargeHub**<sup>®</sup>  
THE USB SUPERCHARGER

X3

X5



# User Manual

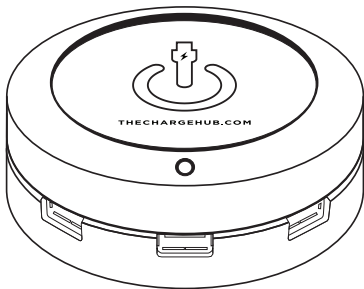

USB SuperCharger



# Table of Contents

---

General Safety Information .....	2
Care and Maintenance.....	3
Introduction.....	4
What's Included.....	5
Components.....	6
ChargeHub Setup.....	7-10
ChargeHub Custom Insert .....	11-12
Overdraw Protection .....	13
Certification.....	14
Notice to International Users.....	15
DesignStudio .....	16
Recommended Accessories.....	17
ChargeHub Technical Specifications .....	18
ChargeHub Limited Warranty .....	19-25
Copyright Notice.....	26
FCC Notice.....	27



# General Safety Information

---

**FOR THE SAFE AND SUCCESSFUL OPERATION OF THIS PRODUCT, PLEASE READ AND FOLLOW THE INFORMATION CONTAINED IN THIS USER MANUAL BEFORE USE.**



Do not open ChargeHub as contents may cause electric shock.



For proper operation, use only approved ChargeHub-branded electronics and components as well as specified compatible electronic devices.



The majority of states have laws prohibiting the use of mobile devices while driving. ChargeHub does not condone such usage and strongly recommends against it, regardless of local law. Any use of a mobile device while driving is at the users sole risk and ChargeHub assumes no liability of any kind therefore. Please drive safely.

# Care and Maintenance

---

- Please keep the ChargeHub and all accessories out of reach of small children.
- Do **NOT** use third party power supplies or non-approved adapters with the ChargeHub.
- Do **NOT** attempt to open the outer casing of the product.
- Do **NOT** clean the ChargeHub with harsh chemicals and keep the ChargeHub away from liquids.
- Do **NOT** expose the ChargeHub to extreme temperatures.
- Do **NOT** paint or apply coatings to the ChargeHub, as you might affect moving parts or damage internal components.
- Do **NOT** stick foreign objects in any port/opening of the ChargeHub. Doing so may cause electric shock.
- Do **NOT** attempt to disassemble or repair the ChargeHub. Contact customer service for technical assistance at 855-843-4828.



# Introduction

---

ChargeHub is designed for use with small electronic devices such as cell phones, tablets, MP3 players, gaming devices, Bluetooth® headsets, navigation units, video/digital cameras, mobile hot-spots, portable power chargers, etc. It allows users to charge USB devices simultaneously. Charge time may vary based on the particular device, battery limitations, and/or battery capacity.

ChargeHub works by using standard USB cables to connect to your devices. Adapters for most consumer electronics manufacturers worldwide are available for purchase under the CableLinx brand.

For up-to-date compatibility charts, product assistance, or to purchase additional CableLinx USB cables or other ChargeHub accessories, please visit our website: [TheChargeHub.com](http://TheChargeHub.com)

**Note: The ChargeHub may not be compatible with all USB chargeable devices. This model is not designed for charging notebook computers or other high current devices. (See Technical Specifications Table on page 18)**



# What's Included

---

The ChargeHub package contains the following:

- (1) ChargeHub USB SuperCharger
- (1) AC Power Cord
- (1) User Manual
- (1) Clear Lens with Removable Film
- (1) Logo Branded Insert

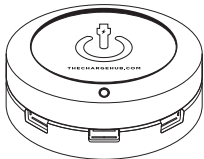
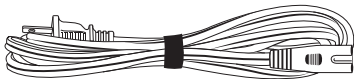

\*Some models may include USB charging cables or accessories



# Components

---

1. LED Power Indicator Light
2. USB Charging Ports (Output)
3. AC Power (Input)
4. AC Power Cord
5. Logo Branded Insert

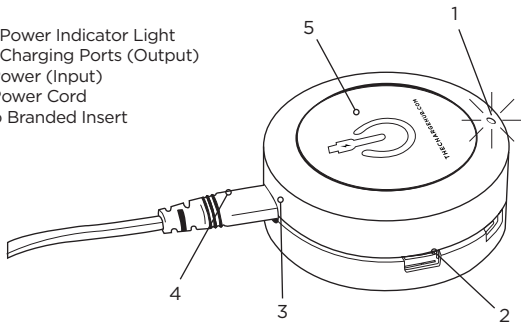

# ChargeHub Setup

---

Plug AC power cord into AC Power Input of ChargeHub.

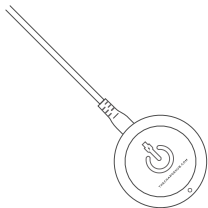

Plug AC power cord into wall outlet.

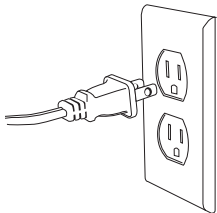

## ChargeHub Setup cont'd

---

Power indicator light will illuminate.

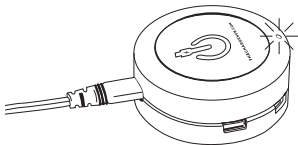

Plug USB cable into charging port of ChargeHub (sold separately).

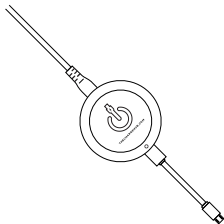

# ChargeHub Setup cont'd

---

Plug USB cable into your device.

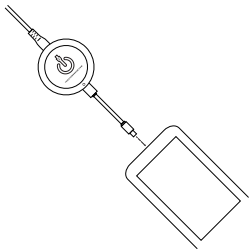

Enjoy your fully charged device.

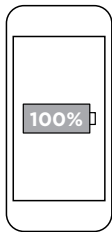

\*Charge times may vary by device.



## ChargeHub Setup cont'd

---

Repeat steps from pages 8-9 to add additional devices to the ChargeHub.

Please note the ChargeHub X3 has a total max output of 5V/5A (25W) and the X5 has a max output of 5V/8A (40W). Exceeding these limits may cause the ChargeHub to go into over draw protection. Refer to page 13 for additional on overdraw protection information.

\*ChargeHub X3 Model Shown

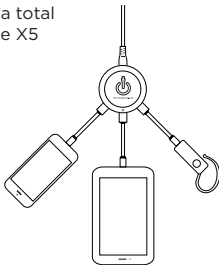

# ChargeHub Custom Insert \*Optional

---

Use our free DesignStudio to create your own custom insert. Simply upload a picture, print, cut out and place your custom insert over the original.

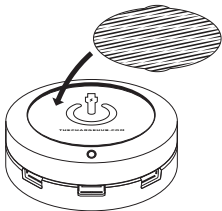

To protect your custom insert, remove the Clear Lens from the tray and peel the film from the front and back sides.



# ChargeHub Custom Insert \*Optional

---

Place clear lens on your insert by tucking the ears of the lens into the notch of the ChargeHub to protect custom insert.

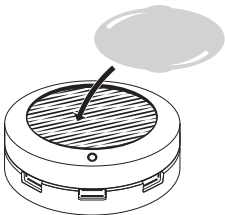



# Overdraw Protection

---

When multiple devices are connected, the ChargeHub may at times reach its maximum charge capacity. Once this occurs, the unit will start blinking and connected devices should be temporarily disconnected one by one until the blinking stops. Once the connected devices consume less power and the blinking stops, the user should wait a short period of time and begin to reconnect the devices one by one to resume charging.



# Certification

---

## **Certification**

ChargeHub is UL/cUL certified and tested to comply with FCC Standard Part 15 for safety and reliability under the United States and Canadian standards. ChargeHub is compliant with requirements for Energy Efficiency Level VI.

**Unauthorized changes or modifications to this device may impair the user's ability to operate this device and will void the warranty.**

## **UL/cUL and FCC Notice to Users**

Users are not permitted to make changes or modify this device or any of its companion products or components in any way. Changes or modifications are considered a safety hazard/risk and will void the warranty.

# Notice to International Users

---

Prior to traveling outside of North America, please make sure to have a compatible ChargeHub branded plug adapter to use in the country being traveled to. International plug adapters can be purchased separately by visiting our website at:

**[TheChargeHub.com/store](http://TheChargeHub.com/store)**



# DesignStudio

---

Use our FREE online DesignStudio ([TheChargeHub.com/designer](http://TheChargeHub.com/designer)) to customize your ChargeHub with any photo, text, logo or graphic.

**IT'S AS EASY AS:**

**1**



**UPLOAD**

**2**



**PERSONALIZE**

**3**



**PRINT**

— 16 —



## Recommended Accessories (sold separately)

---

- **CableLinx USB Cables**
- **Travel Case**
- **International Travel Adapters**

It is critical to use ChargeHub-branded power supplies and approved adapters, only. Use of non-approved ChargeHub products may cause safety hazards and damage your personal electronic devices under charge. For a list of approved ChargeHub accessories, visit our website at:

**[TheChargeHub.com/store](http://TheChargeHub.com/store)**



# ChargeHub Technical Specifications

---

Specifications	X3	X5	Units
Input Voltage	100-240	100-240	VAC
Total Power	25	40	Watts
Max Output Voltage	5	5	VDC
Max Current Per Port	2.4	2.4	Amps
Max Total Current	5	8	Amps
Efficiency	85.06	86.06	%
PC Board Dimensions	3.25 x 3.25 x 1.00	3.25 x 3.25 x 1.00	Inches

# ChargeHub Limited Warranty

---

Subject to the exclusions contained below, Limitless Innovations, Inc. (“ChargeHub or Company”) warrants ChargeHub Products to be free from defects in materials and workmanship under normal consumer usage for a period of one (1) year from the date of original purchase, (the “ChargeHub Limited Warranty”). ChargeHub Products (or the singular, ChargeHub Product) shall include all products manufactured and sold by ChargeHub, including but not limited to all ChargeHub SuperChargers, ChargeHub V2, vehicle chargers, cables, power cables, travel adapters, Bluetooth® speakers, power banks, decals, inserts and all other products that may be sold by ChargeHub now or in the future.

This ChargeHub Limited Warranty is a consumer’s sole and exclusive remedy regarding any express warranty claim by a consumer and is subject to the exclusions of the following:



# ChargeHub Limited Warranty cont'd

---

**Exclusions:** The ChargeHub Limited Warranty shall not apply in the event of the occurrence of any of the following:

- 1. Normal Wear and Tear.** The ChargeHub Limited Warranty shall not apply to cover the maintenance, repair and/or replacement of parts or the ChargeHub Product due to normal wear and tear by the consumer.
- 2. Abuse and Misuse.** The ChargeHub Limited Warranty shall not cover defects or damage that result in whole or in part from: (a) improper operation, storage, misuse or abuse, accident or neglect by the consumer (including, without limitation, physical damage, cracks and scratches to the surface of the ChargeHub product); (b) contact with liquid, water, rain, extreme humidity or heavy perspiration, sand, dirt or the like, extreme heat, or food; (c) use of the ChargeHub Product for commercial purposes; (d) subjecting the ChargeHub Product to abnormal usage or conditions; and/or (e) other acts which are not the sole and absolute fault of ChargeHub.



# ChargeHub Limited Warranty cont'd

---

**3. Unauthorized Service or Modification.** The ChargeHub Limited Warranty shall not cover defects or damages resulting in whole or in part from service, testing, adjustment, installation, maintenance, alteration, or modification in any way by someone other than ChargeHub or its authorized service centers.

**4. Altered Products.** The ChargeHub Limited Warranty shall not cover defects or damages to a ChargeHub Product with (a) serial numbers or date tags that have, at any time, been removed, altered, or obliterated; (b) broken seals or evidence of tampering; (c) mismatched board serial numbers; and/or (d) non-conforming or non-ChargeHub housings, or components.

**5. Communication Services.** Defects, damage, or the failure of ChargeHub Products or software due to any communication service or signal you may subscribe to or use with the ChargeHub Product or software.



# ChargeHub Limited Warranty cont'd

---

## **Who is Covered?**

This warranty extends only to the first consumer purchaser from Limitless Innovations and is not transferable to any third party nor applicable to any subsequent owner other than the first consumer purchaser from Limitless Innovations, Inc.

## **What Will ChargeHub Do?**

If Limitless Innovations, Inc. determines, in its sole and absolute discretion, that a claim is subject to the ChargeHub Limited Warranty, it will, at its sole option, repair or replace the ChargeHub Product or alternatively, it will, in its discretion, refund the purchase price of any ChargeHub Products or software. ChargeHub Product replacement will be with a functionally equivalent reconditioned / refurbished / pre-owned or new ChargeHub Product or part.

For additional information, visit us at:

**[TheChargeHub.com/support](http://TheChargeHub.com/support) or call us at 855-843-4828**

# ChargeHub Limited Warranty cont'd

---

In the event of any warranty claim under the ChargeHub Limited Warranty, you can contact the telephone number below or provide a written correspondence to the address below at which time and in response thereto, you will receive instructions on how to ship any ChargeHub Product at your expense, to a ChargeHub authorized repair center. To obtain service, you must include: (a) a copy of your receipt, bill of sale or other comparable proof of purchase; (b) a written description of the problem; (c) the name of your service provider, if applicable; and (d) your mailing address, email address and telephone number.

## **Mailing Address (Please call 855-843-4838 first to obtain RMA #)**

Limitless Innovations  
4800 Metalmaster Way  
McHenry, IL 60050



# ChargeHub Limited Warranty cont'd

---

## **What Other Limitations Are There?**

ANY WARRANTY CLAIM SHALL BE LIMITED TO LIMITLESS INNOVATIONS, INC.'S COST OF MATERIAL ON THE CHARGEHUB PRODUCT DETERMINED TO HAVE A MANUFACTURER'S DEFECT. IN NO EVENT SHALL LIMITLESS INNOVATIONS, INC. BE LIABLE TO ANY PARTY FOR ANY LABOR COSTS OR ANY OTHER DIRECT, INDIRECT, CONSEQUENTIAL, INCIDENTAL OR SPECIAL DAMAGES, WHETHER IN CONTRACT OR TORT AND EXPRESSLY DISCLAIMS LIABILITY FOR ANY DAMAGES OF ANY KIND ARISING UNDER ANY THEORY OF LAW WHATSOEVER. THE PERFORMANCE OF THE CHARGEHUB PRODUCT DEPENDS ON THE PURCHASER'S ADHERENCE TO MANUFACTURER PRODUCT INSTRUCTIONS AND LIMITLESS INNOVATIONS, INC. WILL NOT BE RESPONSIBLE TO PURCHASER FOR ANY DEVIATIONS THEREFROM. SOME STATES DO NOT ALLOW THE EXCLUSION OR LIMITATION OF INCIDENTAL OR CONSEQUENTIAL DAMAGES, SO THE ABOVE LIMITATION OR EXCLUSION REGARDING INCIDENTAL OR CONSEQUENTIAL DAMAGES MAY NOT APPLY TO YOU. ALL IMPLIED WARRANTIES, INCLUDING, WITHOUT LIMITATION, THE IMPLIED WARRANTY OF MERCHANTABILITY AND THE IMPLIED WARRANTY OF FITNESS FOR A PARTICULAR PURPOSE SHALL EXPIRE ON THE DATE WHICH IS (1) YEAR FROM THE DATE OF FIRST PURCHASE OF THE CHARGEHUB PRODUCT BY THE CONSUMER. SOME STATES DO NOT ALLOW LIMITATIONS ON HOW LONG AN IMPLIED WARRANTY LASTS, SO THE ABOVE LIMITATION MAY NOT APPLY TO YOU. WITH RESPECT TO THAT PERIOD OF TIME BEYOND THE CHARGEHUB (1) YEAR LIMITED WARRANTY PERIOD, LIMITLESS INNOVATIONS, INC. DISCLAIMS AND FURTHER MAKES NO WARRANTY OF ANY KIND, EXPRESS OR IMPLIED, INCLUDING BUT NOT LIMITED TO, ANY WARRANTY OF MERCHANTABILITY OR WARRANTY OF FITNESS FOR A PARTICULAR PURPOSE.

# ChargeHub Limited Warranty cont'd

---

PLEASE NOTE THAT THIS CHARGEHUB LIMITED WARRANTY GIVES YOU SPECIFIC LEGAL RIGHTS, AND YOU MAY ALSO HAVE OTHER RIGHTS WHICH VARY FROM STATE TO STATE.

## **NATIONAL STATUTORY RIGHTS**

CONSUMERS IN SOME JURISDICTIONS MAY HAVE LEGAL RIGHTS UNDER APPLICABLE NATIONAL LEGISLATION GOVERNING THE SALE OF CONSUMER GOODS, INCLUDING, WITHOUT LIMITATION, NATIONAL LAWS IMPLEMENTING EC DIRECTIVE 99/44. THESE RIGHTS ARE NOT AFFECTED BY THE WARRANTIES IN THIS LIMITED WARRANTY.

YOUR USE OF THE PRODUCT SHALL AT ALL TIMES REQUIRE YOU TO COMPLY WITH ALL TERMS, CONDITIONS OF USE, INSTRUCTIONS AND RECOMMENDATIONS SET FORTH WITHIN THE CHARGEHUB USER MANUAL FOUND AT: [TheChargeHub.com/user-manual/manual-x3-x5.pdf](http://TheChargeHub.com/user-manual/manual-x3-x5.pdf)

YOUR USE OF CHARGEHUB SHALL BE GOVERNED BY THIS CONSUMER RIGHTS AND ARBITRATION AGREEMENT, this ("AGREEMENT").

THIS AGREEMENT AFFECTS YOUR LEGAL RIGHTS AND REMEDIES BY PROVIDING THAT DISPUTES BETWEEN YOU AND THE MANUFACTURER OF THIS PRODUCT, LIMITLESS INNOVATIONS, INC., AN ILLINOIS CORPORATION ("COMPANY"), MUST BE RESOLVED THROUGH BINDING ARBITRATION, RATHER THAN IN A COURT. PLEASE READ THIS AGREEMENT CAREFULLY AS YOU ACCEPT THE TERMS OF THIS AGREEMENT BY RETAINING THE PRODUCT(S) PURCHASED IN CONNECTION WITH THIS AGREEMENT ("PRODUCT") FOR MORE THAN FOURTEEN (14) DAYS. IF YOU DO NOT AGREE TO THE



# ChargeHub Limited Warranty cont'd

---

TERMS OF THIS AGREEMENT AND YOU PURCHASED THE PRODUCT DIRECT FROM COMPANY (VIA WEB OR TELEPHONE), CALL 855-843-4828 TO COORDINATE THE RETURN OF THE PRODUCT TO COMPANY WITHIN FOURTEEN (14) DAYS OF RECEIPT AT NO COST TO YOU. IF YOU PURCHASED THE PRODUCT ELSEWHERE, WITHIN FOURTEEN (14) DAYS OF PURCHASE YOU MUST CALL 855-843-4828 AND THEN, ALSO WITHIN THIS SAME FOURTEEN (14) DAY PERIOD, RETURN THE PRODUCT TO THE POINT OF PURCHASE. FOR ANY QUESTIONS RELATED TO THE ABOVE, PLEASE CALL 855-843-4828.

## Copyright Notice

---

All ChargeHub products and information shared in this manual are protected by copyright. Copying, reproducing, reverse engineering or distributing any information of ChargeHub related products hardware or software without a formal and written authorization and license from Limitless Innovations, Inc. is prohibited and may result in legal action to the full extent of the law.

# FCC Notice

---

“This device complies with Part 15 of the FCC Rules. Operation is subject to the following two conditions: (1) this device may not cause harmful interference, and (2) this device must accept any interference received, including interference that may cause undesired operation.”

“Warning: Changes or modifications to this unit not expressly approved by the party responsible for compliance could void the user’s authority to operate the equipment.”

“NOTE: This equipment has been tested and found to comply with the limits for a Class B digital device, pursuant to Part 15 of the FCC Rules. These limits are designed to provide reasonable protection against harmful interference in a residential installation. This equipment generates, uses and can radiate radio frequency energy and, if not installed and used in accordance with the instructions, may cause harmful interference to radio communications.”

However, there is no guarantee that interference will not occur in a particular installation. If this equipment does cause harmful interference to radio or television reception, which can be determined by turning the equipment off and on, the user is encouraged to try to correct the interference by one or more of the following measures:

- Reorient or relocate the receiving antenna.
- Increase the separation between the equipment and receiver.
- Connect the equipment into an outlet on a circuit different from that to which the receiver is connected. Consult the dealer or an experienced radio/TV technician for help.





All rights reserved. ChargeHub is a trademark of Limitless Innovations, Inc. Design and specifications subject to change without notice. All other trademarks included herein are property of their respective owners. Cable adapters sold separately. Electronic devices not included.

Innovated in USA | Made in China

Patent: [TheChargeHub.com](http://TheChargeHub.com)

Phone: (855) 843-4828 | Email: [Sales@LimitlessInnovations.com](mailto:Sales@LimitlessInnovations.com)

Website: [TheChargeHub.com](http://TheChargeHub.com)

© Limitless Innovations, Inc.